

PREPARE PRODUCT DISPLAY PANELS

REQUIRED FOR BOTH GRID & WALL MOUNT OPTIONS



RETAIL WALL DISPLAY INSTALLATION

SECTION-11
FENDER FLARES / DELUXE WHEELS

PREPARING PANEL 11B - DELUXE WHEELS

RWD WHEEL HW

- 1/2"-20 x 3-1/2" Hex Bolt (x4)
- 1/2" Washer (x8)
- 1/2"-20 Nut (x4)
- 1/2"-20 Lug Nut (x4)

[A]

Add washer and install bolt through the back of panel

Fully tighten all 4 bolts using 3/4" wrench & socket

NOTE: Fully tighten Hardware.

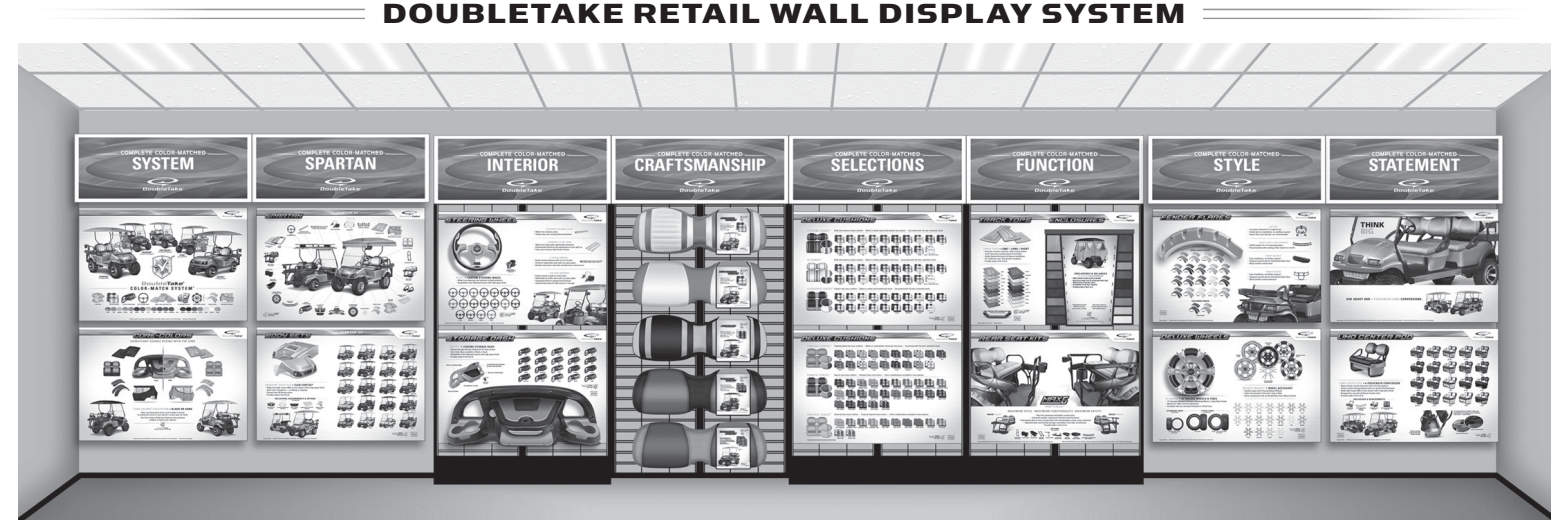

IMPORTANT: Do not fully tighten hardware until instructed. Read through all instructions before beginning installation.

**** IMPORTANT ****
STEERING WHEEL PANEL REQUIRES EXTRA SUPPORT - GRID MOUNT & WALL MOUNT

GRID MOUNT

RWD SNGL GRID HW

- Fast Lead Captive Screw
- Fast Lead Receiver

[B]

B] Grid Mount & Wall Mount: When mounting the Steering Wheel Panel make sure to install the extra mounting support before installing the Steering Wheel product.

WALL MOUNT

RWD SNGL WALL HW

- 1/4" Flat Washer (x1)
- #8 EZ Wall Anchor (x1)
- #8 x 2" Screws (x1)
- 1/4"x 1" Black Spacer (x1)

[C]

C] Position the Wheel onto the protruding bolts. Secure the Wheel with 4 Lug Nuts.

NOTE: Fully tighten Hardware.

[D]

D] Align the Wicked Wheel Insert and snap into Wheel. Snap Hub Cap into the Wicked Wheel Insert and install decal.

TABLE OF CONTENTS

Display System Introduction:

- Mounting Options pg 2-3
- Sections Layout & Overview pg 2-3

Panel & Header Installation:

Grid Mount Option

- Prepare Product Display Panels pg 12-16
- 1] Install Display Panels pg 4
- 2] Install Display Headers pg 5
- 3] Install Cushion Samples (Grid) pg 5

Wall Mount Option

- Prepare Product Display Panels pg 12-16
- 1] Assemble Installation Jigs pg 6
- 2] Establish Panel Positions pg 7-8
- 3] Establish Header Positions pg 9
- 4] Final Installation pg 9
- 5] Install Cushion Samples (Wall) pg 10-11

Prepare Product Display Panels:

- Section 07
 - Panel 07A - Steering Wheel pg 12
 - Panel 07B - Sentry Dash pg 13
- Section 08
 - Cushion Samples (No Panels) pg 10-11
- Section 10
 - Panel 10A - Track Top & Enclosures pg 14
- Section 11
 - Panel 11A - Fender Flares pg 15
 - Panel 11B - Deluxe Wheels pg 16

THIS IS MORE THAN JUST ANOTHER RETAIL DISPLAY. THIS IS A COMPLETE SYSTEM DESIGNED TO HELP YOU SELL MORE CUSTOM GOLF CARS.

This Retail Display System was developed to meet several objectives:

- To create a complete retail system for designing and selling customized golf cars, and not to be just another device for displaying random individual products
- To provide a sales tool that leads customers through the customization process by presenting a mix of physical product samples and engaging information panels that visually explain available options, colors, etc.
- To look professional, command attention, and promote brand awareness
- To be modular so that you can configure it to best suite your needs
- To easily fit existing commercial display grids already in the marketplace
- The ability to also be installed directly to walls without a commercial display grid
- To be affordable, provide value, and to help you sell more cars with more upgrades

MODULAR DESIGN ALLOWS YOU TO CHOOSE SECTIONS AND CONFIGURE THEM TO WORK BEST FOR YOU.

Our Retail Wall Display System was engineered with a singular focus...to help you sell more custom cars. With a mix of physical product samples and available options, this vibrant, information-filled system will engage your customers and lead them through the customization design process. Now you can give them exactly what they want, and sell it before you commit resources to build it.

DETERMINE WHICH MOUNTING OPTION IS RIGHT FOR YOUR INSTALL

GRID MOUNT OPTION

(See pages 4-5 for installation instructions)



Display Wall Grid not provided

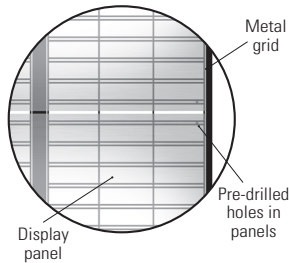

Metal grid

Pre-drilled holes in panels

- Grid size required to install a full Display Section: 48" x 96"
- All Display Panels have predrilled mounting holes that align with most standard display wall grids (*grid not provided*)
- Quick and easy installation with Fast-lead Screws and Receivers
- Headers install easily with adhesive-backed velcro

WALL MOUNT OPTION

(See pages 6-11 for installation instructions)

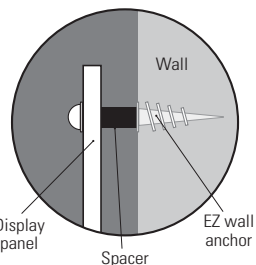

Display panel

Spacer

EZ wall anchor

- Wall space required to install a full Display Section: 49-1/4" x 96"
- All Display Panels have predrilled mounting holes. Each Header requires 5/16" mounting holes to be drilled in all four corners
- Mounting requires: 1" Black Spacers, EZ Wall Anchors, 4"x 4"x 1" Plank Foam Spacers
- Installation Jig (included) is required for consistent panel installation

SECTION-01 COLOR-MATCH SYSTEM / CORE COLORS



SECTION-02 SPARTAN CAR KIT / BODY SET



SECTION-07* PILOT STEERING WHEEL / SENTRY DASH



SECTION-08* DELUXE CUSHIONS (PHYSICAL SAMPLES)



SECTIONS SOLD SEPARATELY •

DISPLAY PANELS

WALL MOUNT OPTIONS

SECTION-11 FENDER FLARES / DELUXE WHEELS



PREPARING PANEL 011A - FENDER FLARES

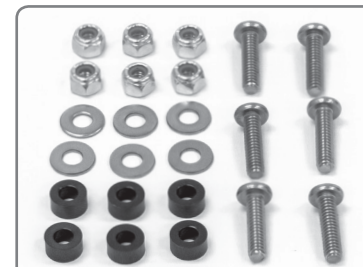

RWD FNDR FLR HW

- 1/4" x 1" Pan Head Bolt (x6)
- 1/4" Flat Washer (x6)
- 1/4" Nyloc Nut (x6)
- 1/4" x 1/4" Black Spacer (x6)

POSITION FENDER FLARE ON PANEL



Front Driver Fender Flare



Rear Passenger Fender Flare

E The Fender Flare product will vary. You will have received one of the four Fender Flares (Front or Rear—Driver or Passenger side). Position your particular Fender Flare to the Panel where it looks best in the available space.

MARK - DRILL 5/16" HOLES - INSTALL



F Hold the Fender Flare secure and mark hole locations. Drill 5/16" holes at all marks.

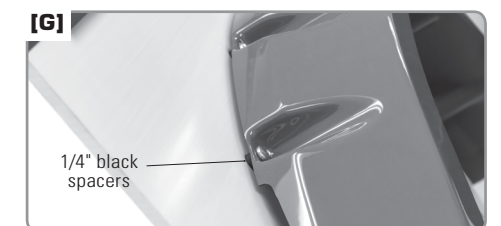

1/4" black spacers

NOTE: Fully tighten Hardware.

G Install the Fender Flare using 1/4" x 1" Pan Head Bolts, Black Spacers, Washers and Nyloc Nuts.

PREPARE PRODUCT

REQUIRED FOR BOTH GRID &

SECTION-10 TRACK TOPS & ENCLOSURES (PANEL 10A)



PREPARING PANEL 10A - TRACK TOPS & ENCLOSURES

ATTACH TOP HANDLE



RWD TOP HANDLE HW

- 1/4" x 2" Pan Head Bolt (x1)
- 1/4" Flat Washer (x2)
- 1/4" Nyloc Nut (x2)
- Top Handle (x1)

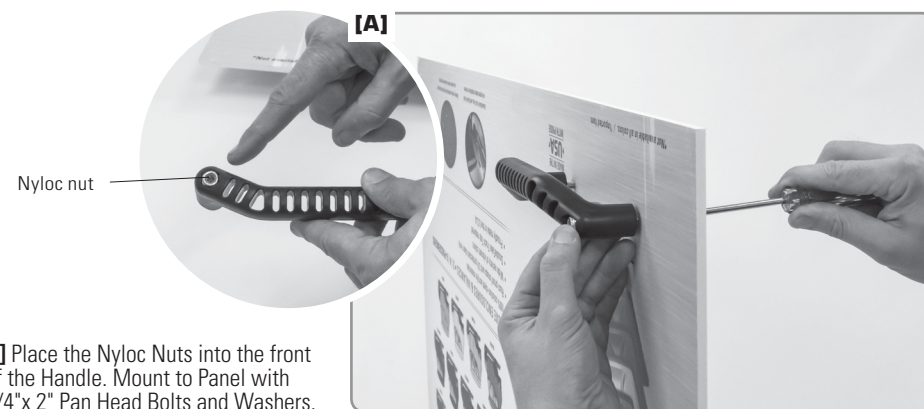

A] Place the Nyloc Nuts into the front of the Handle. Mount to Panel with 1/4"x 2" Pan Head Bolts and Washers.

NOTE: Fully tighten Hardware.

ATTACH KWICK TRACK ENCLOSURE RAIL



RWD ENC RAIL HW

- 1/4" x 1-3/4" Pan Head Bolt (x2)
- 1/4" Flat Washer (x4)
- 1/4" Nyloc Nut (x2)

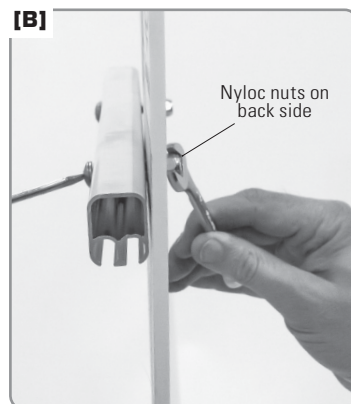

B] Mount the Kwick Track Enclosure Rail to the panel using 1/4"x 1-3/4" Pan Head Bolts, Washers and Nyloc Nuts.

NOTE: Fully tighten Hardware.



C] Slide Enclosure Samples into the rear track of Enclosure Rail.



D] Slide Enclosure Cover Flap into the front track of Enclosure Rail.

SECTION-03 PRECEDENT CAR KIT / BODY SET



SECTION-04 PHANTOM CAR KIT / BODY SET



SECTION-05 TITAN CAR KIT / BODY SET



SECTION-06 VORTEX CAR KIT / BODY SET



SECTION-09 DELUXE CUSHIONS (COLOR OPTIONS)

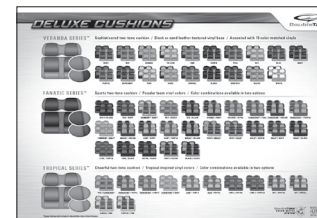
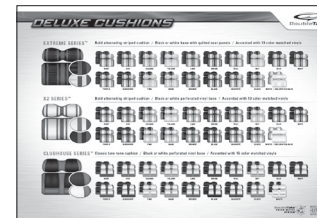

SECTION-10* TRACK TOPS / ENCLOSURES / REAR SEAT KIT

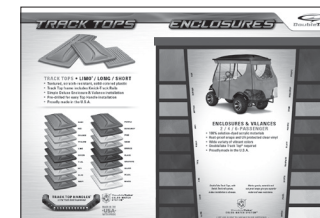

SECTION-11* FENDER FLARES / DELUXE WHEELS

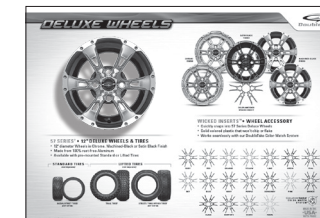
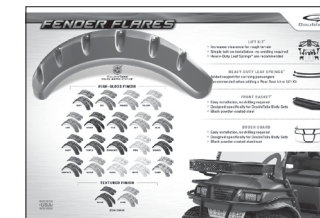

SECTION-12 6-PASSENGER CONVERSIONS / LIMO POD



* Panels contain physical product samples

MUST BE PURCHASED IN FULL SECTIONS ONLY • SECTIONS CANNOT BE SPLIT • NO SUBSTITUTIONS

WALL MOUNT INSTALLATION JIGS

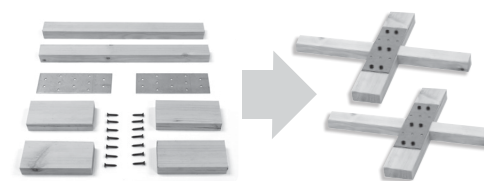

- Installation Jig Kit contains parts & hardware for 2 Spacing Jigs
- Designed to make Display Panel alignment and layout easier and more consistent for wall mounted installation
- Installation Jigs provide the minimal required horizontal and vertical spacing between panels and headers, without having to measure

GRID MOUNT

PANEL & HEADER INSTALLATION

PREPARE ALL PRODUCT DISPLAY PANELS FOR INSTALL (Pages 10-16)

If you have Sections that feature physical product, prepare the panels before beginning installation.

Sections with Product Panels:

- Section 07
 - Panel 07A - Steering Wheel...pg 12
 - Panel 07B - Sentry Dash...pg 13
- Section 08
 - Cushion Samples (No Panels)...pg 10-11
- Section 10
 - Panel 10A -Track Tops & Enclosures...pg 14
- Section 11
 - Panel 11A - Fender Flares...pg 15
 - Panel 11B - Deluxe Wheels...pg 16

1) INSTALL DISPLAY PANELS

• Determine the sequence of the Display Sections and install Display Panels to the wall grid using the diagram to the right as a guide.

2) INSTALL DISPLAY HEADERS

• Next, Install Headers using adhesive-backed velcro.

3) INSTALL CUSHION SAMPLES

• Install Cushion hardware and establish correct spacing

1 INSTALL DISPLAY PANELS

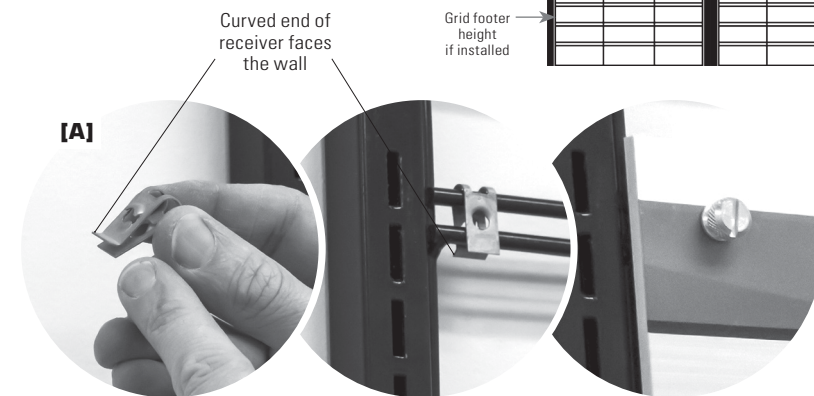
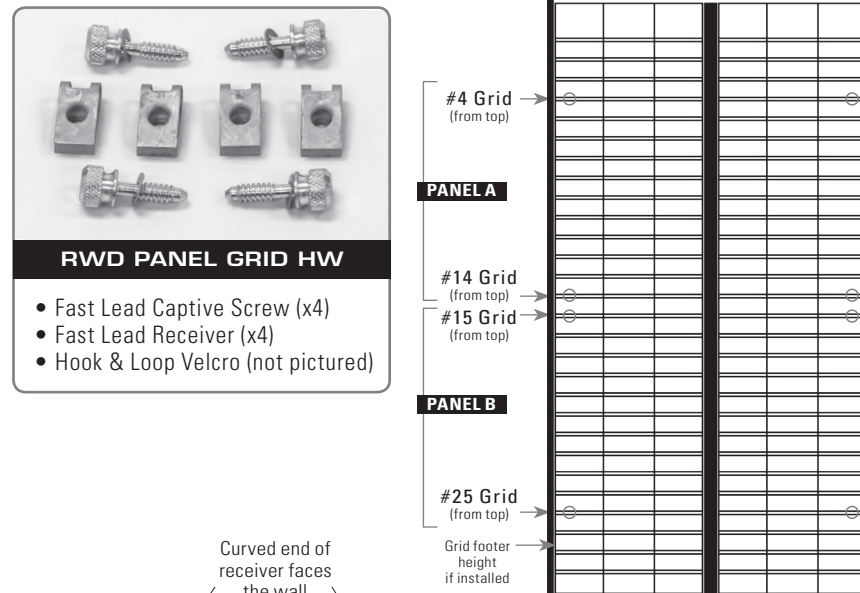

A] Do not fully tighten screws until all 4 have been started. This will allow the receivers to slide along the grid to help with final positioning. Fully tighten screws once panel is in place.

** IMPORTANT ** PRODUCT PANELS THAT REQUIRE EXTRA SUPPORT

The Steering Wheel and Deluxe Wheels Display Panels require extra mounting support. Be sure to attach panels to grid where indicated, before installing product to the panels.



RWD SNGL GRID HW

- Fast Lead Captive Screw
- Fast Lead Receiver

PANEL 07A STEERING WHEEL - REQUIRES EXTRA GRID MOUNT -

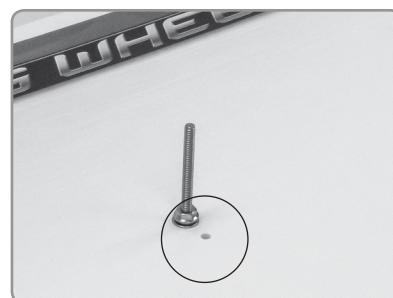

PANEL 11B DELUXE WHEEL - REQUIRES EXTRA GRID MOUNT -

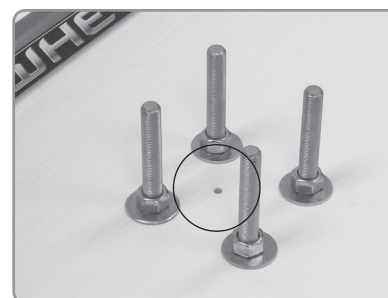

DISPLAY PANELS

WALL MOUNT OPTIONS

SECTION-07 PILOT STEERING WHEEL / SENTRY DASH



PREPARING PANEL 07B - SENTRY DASH

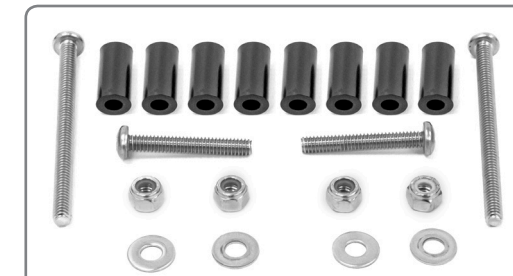

RWD DASH HW

- 1/4" x 4" Pan Head Bolt (x2)
- 1/4" x 1-3/4" Pan Head Bolt (x2)
- 1/4" x 1" Black Spacer (x8)
- 1/4" Nyloc Nut (x4)
- 1/4" Flat Washer (x4)

- 1-3/4" Pan Head Bolt
- 1" Black Spacer x1
- 4" Pan Head Bolt
- 1" Black Spacers x3



H] Insert 4" Pan Head Bolts into the top two center holes of the Dash and add three 1" Black Spacers onto each bolt.

• Next, insert 1-3/4" Pan Head Bolts into each outside hole of Dash and add a single 1" Black Spacer onto each bolt.



I] Insert all four bolts into the predrilled holes in Display Panel and attach with Flat Washers and Nyloc Nuts.

— NOTE: If predrilled holes are too tight, drill with a 5/16" bit to open them slightly.

PREPARE PRODUCT

REQUIRED FOR BOTH GRID &

SECTION-07
PILOT STEERING WHEEL / SENTRY DASH

COMPLETE COLOR-MATCHED INTERIOR
DoubleTake

STEERING WHEEL
COMPLETE COLOR-MATCHED SYSTEM
DoubleTake

STORAGE DASH
COMPLETE COLOR-MATCHED SYSTEM
DoubleTake

PREPARING PANEL 07A - STEERING WHEEL

RWD ST WHEEL HW

- 1/4" x 3" Pan Head Bolt (x1)
- 1/4" Flat Washer (x2)
- 1/4" Lock Washer (x2)
- 1/4" Fender Washer (x1)
- 1/4" Flange Nut (x2)

A] Install Flat Washer onto 3" Pan Head Bolt and insert through the back of the Panel in the Top Hole.

B] Install hardware as shown and fully tighten. Set aside Panel and remaining hardware for later.

NOTE: Fully tighten Hardware.

Flat washer

Flange nut
Lock washer
Flat washer
Top hole

**** IMPORTANT ****

STEERING WHEEL PANEL REQUIRES EXTRA SUPPORT - GRID MOUNT & WALL MOUNT

GRID MOUNT

RWD SNGL GRID HW

- Fast Lead Captive Screw
- Fast Lead Receiver

C] Grid Mount & Wall Mount: When mounting the Steering Wheel Panel make sure to install the extra mounting support before installing the Steering Wheel product.

- Dramatically Enhance Appearance
- Fully covers face of panel
- Easily mounts to grid
- Pivots for adjustment
- Broader panoramic view
- Easily mounts to wall

HUB ADAPTER CHROME OR BLACK (Optional)

WALL MOUNT

RWD SNGL WALL HW

- 1/4" Flat Washer (x1)
- #8 EZ Wall Anchor (x1)
- #8 x 2" Screws (x1)
- 1/4" x 1" Black Spacer (x1)

D] Position the Hub Adapter over exposed screw and extra support that was installed above. Next, install the large Fender Washer.

E] Install 1/4" Lock Washer

F] Install 1/4" Flange Nut. Fully tighten until the Hub is secured.

G] Once the Hub Adapter is secure, install the Steering Wheel **G]** according to instructions included in the box.

2 INSTALL DISPLAY HEADER

B] Mate the Hook & Loop Velcro together. Cut to size and attach pieces to header uprights (x4). Remove backing from Velcro.

C] Align Header, make sure it is level, then firmly press to attach to adhesive on Velcro.

3 SECTION 08 - CUSHION SAMPLES (GRID)

RWD ST WHEEL HW

- 1/4" x 3/4" Black Spacer (x2)
- 1/4" Fender Washer (x2)
- 1/4" x 1-3/4" Pan Head Bolt (x2)
- 1" Hook Velcro (Not pictured)

D] Top hole

NOTE: Fully tighten Hardware.

ATTACH CUSHION INFORMATION FLAP

Cut hook velcro to size and attach 2 pieces to loop velcro on Flap

E] Center Flap to one side of cushion

F] Remove backing from velcro and adhere Flap to cushion back (Press firmly)

G] Flap is removable whenever needed

CUSHION SAMPLES - GRID POSITION LAYOUT -

H] COMPLETE COLOR-MATCHED CRAFTSMANSHIP DoubleTake

Row 25 (from floor)

Row 20 (from floor)

Row 15 (from floor)

Row 10 (from floor)

Row 5 (from floor)

Remove Footer if installed

WALL MOUNT

PANEL & HEADER INSTALLATION

PREPARE ALL PRODUCT DISPLAY PANELS FOR INSTALL (Pages 10-16)

If you have Sections that feature physical product, prepare the panels before beginning installation.

Sections with Product Panels:

- Section 07
 - Panel 07A - Steering Wheel...pg 12
 - Panel 07B - Sentry Dash...pg 13
- Section 08
 - Cushion Samples (No Panels)...pg 10-11
- Section 10
 - Panel 10A -Track Tops & Enclosures...pg 14
- Section 11
 - Panel 11A - Fender Flares...pg 15
 - Panel 11B - Deluxe Wheels...pg 16

1) ASSEMBLE INSTALLATION JIGS

• The Installation Jigs provide the recommended spacing between all Panels and Headers for an easier install

2) ESTABLISH PANEL POSITIONS

- Measure, level, and establish first BOTTOM panel position (top 2 screws)
- Use installation jigs to establish first TOP panel position (top 2 screws)

(Continued on next page...)

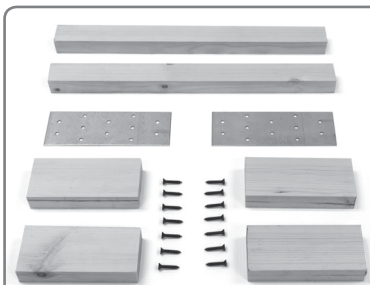

RWD PANEL GRID HW

- Install Jig Long Wood (x2)
- Install Jig Plate (x2)
- Install Jig Short Wood (x4)
- Small Screws

REFERENCE MEASUREMENTS AND DIMENSIONS

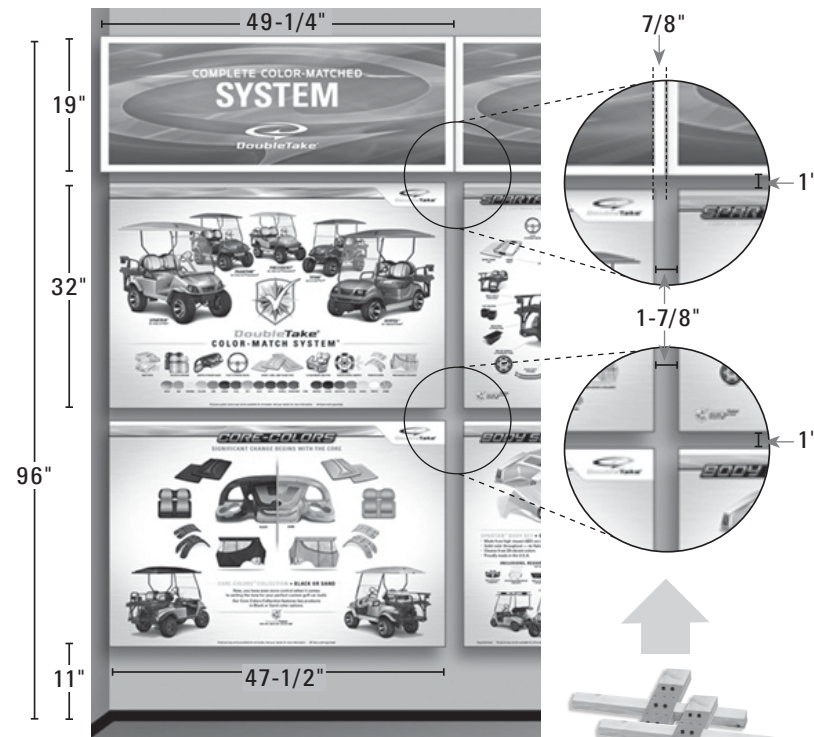

INSTALLATION JIGS
Provide automatic spacing for an easy install

1 ASSEMBLE INSTALLATION JIGS

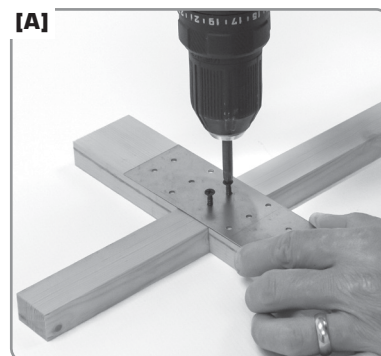

A] Place the Jig Plate across the center of the Long Wood piece (1" wide side).

- Use the 2 Short Wood pieces to align the Plate on cross wood piece (Make sure Plate and Wood pieces are straight and square with cross wood piece).

- Attach Plate to cross wood piece using 2 small screws

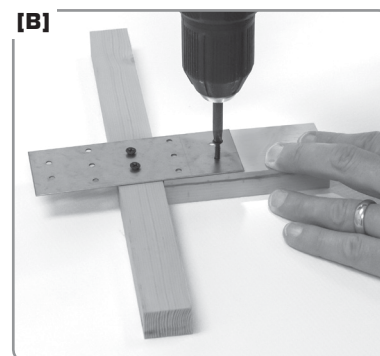

B] Align each Short Wood piece with the Plate and secure with wood screws, making sure they remain straight and square with the 1" cross wood piece.



5 INSTALL CUSHION SAMPLES

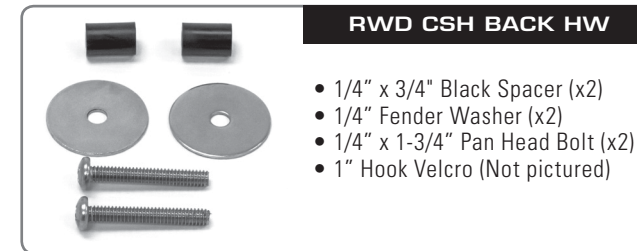

RWD CSH BACK HW

- 1/4" x 3/4" Black Spacer (x2)
- 1/4" Fender Washer (x2)
- 1/4" x 1-3/4" Pan Head Bolt (x2)
- 1" Hook Velcro (Not pictured)

INSTALL HARDWARE

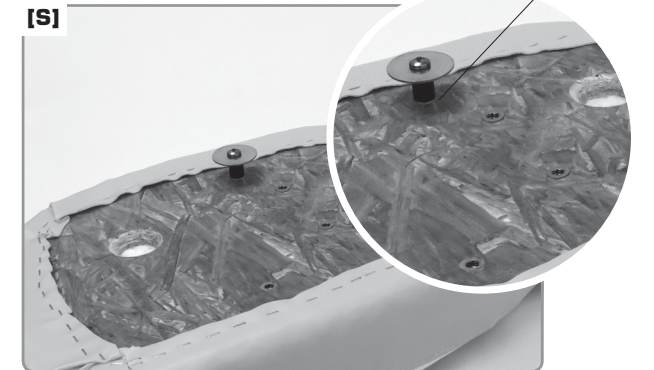

NOTE: Fully tighten Hardware.

ATTACH CUSHION INFORMATION FLAP

Cut hook velcro to size and attach 2 pieces to loop velcro on Flap



Center Flap to one side of cushion

Remove backing from velcro and adhere Flap to cushion back (Press firmly)

Flap is removable whenever needed



W] Mount the Cushion Hanger Wood using provided hardware and 1/2" Black Spacer between wood and wall.



X] Hang Cushions on Wood Hangers.

WALL MOUNT

CUSHION SAMPLE INSTALLATION

5) INSTALL CUSHION SAMPLES

- Install Cushion Sample hardware
- Establish correct spacing and install Cushion Hangers

REFERENCE MEASUREMENTS AND DIMENSIONS

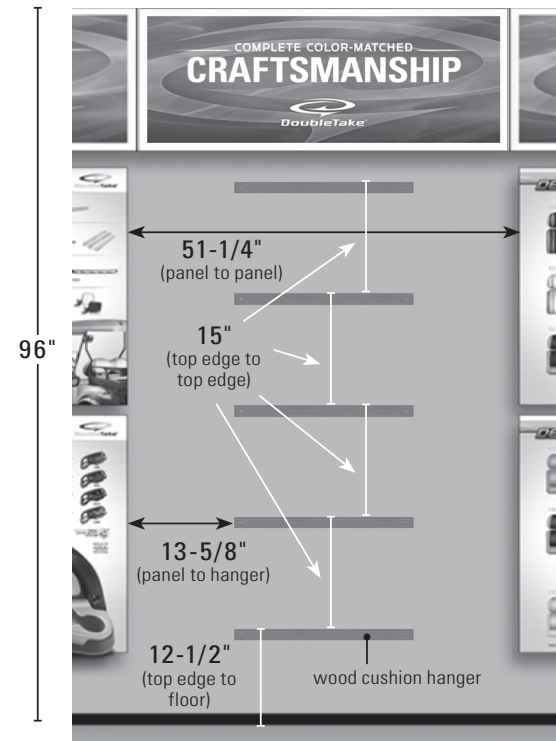

INSTALL THE CUSHION HANGER WOOD SUPPORTS



RWD CSH WALL HW

- Cushion Hanger Wood (x1)
- 1/4" x 1/2" Black Spacer (x2)
- #8 x 2" Screw (x2)
- #8 EZ Wall Anchor (x2)
- 1/4" Flat Washer (x2)



U] See the layout reference above for proper spacing. Position the Cushion Hanger Wood, make sure it's level, and mark hole locations.

V] Install Wall Anchors where marked.

2

ESTABLISH PANEL POSITIONS

ESTABLISH POSITION OF THE FIRST BOTTOM PANEL

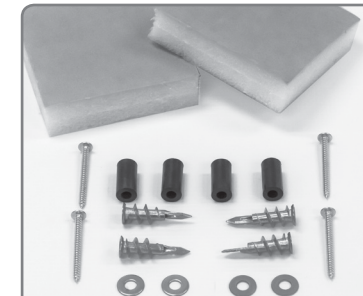

RWD WALL HW

- 4 x 4" x 1" Plank Foam (x2)
 - #8 x 2" Screws (x4)
 - 1/4" x 1" Black Spacer (x4)
 - #8 EZ Wall Anchor (x4)
 - 1/4" Flat Washer (x4)
- (Required for each Panel & Header)

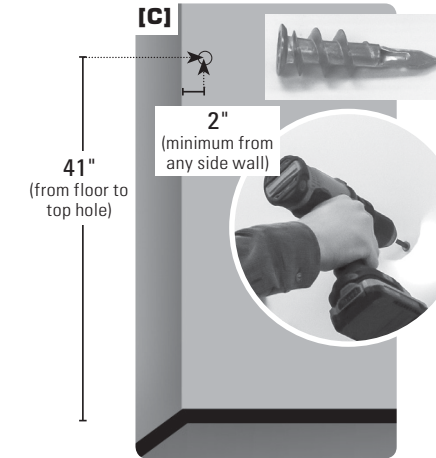

C] Measure up 41" from the floor and at least 2" from any side wall and mark location. Install EZ Wall Anchor

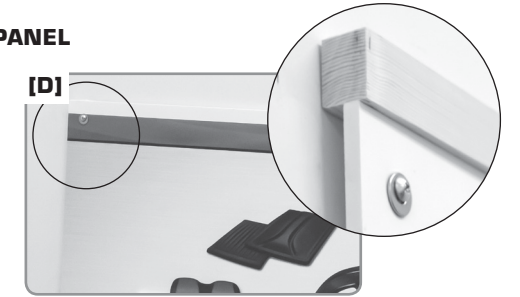

D] Use a Screw and Washer to *TEMPORARILY* attach the Panel. ****DO NOT FULLY TIGHTEN****

- Leave the panel about 1/2" from the wall, so that it can easily support a level and the Installation Jigs. (Do this for all panels during the layout phase. 1" spacers will be added during final installation)

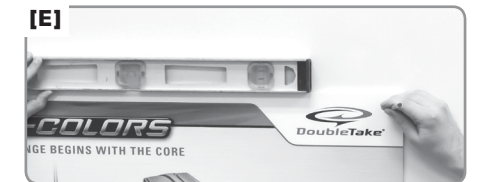

E] Level the Panel and mark the opposite top hole. Lower Panel and install EZ Wall Anchor.

ESTABLISH FIRST TOP PANEL POSITION USING INSTALLATION JIGS

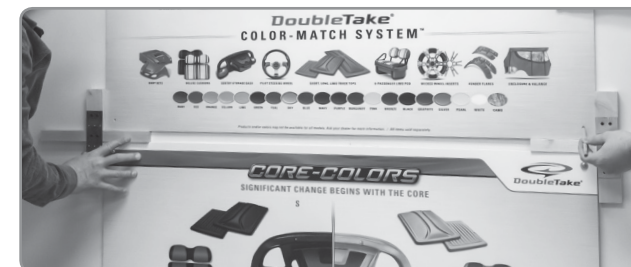

F] Use a Screw and Washer to *TEMPORARILY* attach the Panel on remaining top corner (Only the two top holes should be installed for each panel to establish the full layout).

****DO NOT FULLY TIGHTEN****

- Set the Install Jigs on the top of Panel at each end.
- **** 2-PERSON JOB**** Place the Top Panel onto the Install Jigs. Make sure the Jigs are snug and mark all 4 mounting holes for Top Panel.



G] Remove the Top Panel and set aside. Install all 4 EZ Wall Anchors at marked locations.

**** IMPORTANT ****

Make sure to mark extra holes and install extra Wall Anchors for Product Panel 07A-Steering Wheel (pg 12) & Panel 11B-Deluxe Wheels (pg 16)

Continued on next page

WALL MOUNT

PANEL & HEADER INSTALLATION

2) ESTABLISH PANEL POSITIONS (continued)

- Use installation jig to establish positions for remaining panels (top 2 screws)

3) ESTABLISH HEADER POSITIONS

- Remove cross bar from Install Jig
- Drill 5/16" holes in Header corners (x4)
- Measure to mark Header starting point and then use jig cross bar as spacer to position first Header (top 2 screws)
- Continue to establish positions for remaining Headers

4) FINAL INSTALLATION

- Mark all remaining hole positions in Panels & Headers
- Remove all Panels & Headers / Install wall anchors at all marked locations
- Apply Foam Blocks to backs of Panels & Headers / Re-install all Panels using 1" black spacers

5) INSTALL CUSHION SAMPLES

- Establish correct spacing and install Cushion Hangers (See next page)

2 ESTABLISH PANEL POSITIONS (CONTINUED)



H] ** 2-PERSON JOB** Using the Install Jig on the right edge, position the next Bottom Panel, make sure it's level, and then mark all 4 mounting locations.



I] Use a Screw and Washer to TEMPORARILY attach the Panel in both top corners only. **DO NOT FULLY TIGHTEN******



J] ** 2-PERSON JOB** Place the Top Panel onto the Install Jigs. Make sure the Jigs are snug and mark all 4 mounting holes for Top Panel.

— **NOTE:** If you're installing the *Steering Wheel Panel (07A)* or the *Deluxe Wheel Panel (11B)*, make sure to mark the **EXTRA HOLE** location before installing. See **(J)** above.

- Remove Panel and install Wall Anchors.
- Replace Panel and install top two screws.
- Continue with this process until all top and bottom Panels have been temporarily installed.



G] Use a Screw and Washer to TEMPORARILY attach the Panel in both top corners only. **DO NOT FULLY TIGHTEN******

Do not attach bottom screws at this time. The panel must be removed before final installation.

3 ESTABLISH HEADER POSITIONS

REMOVE 1" CENTER CROSS BAR FROM INSTALL JIGS

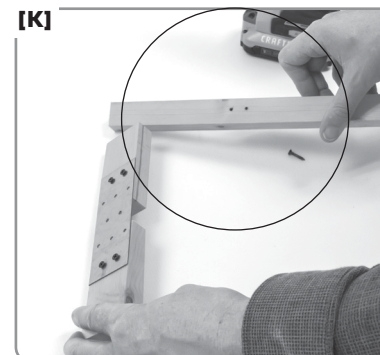

K] Remove the Center Cross Bar piece of wood from the Install Jigs. Set aside the Plate and small wood piece. Only the 1" Cross Bar is required as a spacer for positioning Headers.

DRILL 5/16" HOLES IN HEADER CORNERS

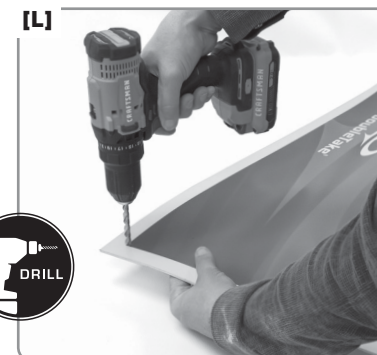

L] Drill 5/16" hole in all four corners of each header. Use the corner where the red meets the white to keep a consistent location.

MARK STARTING POINT FOR FIRST HEADER

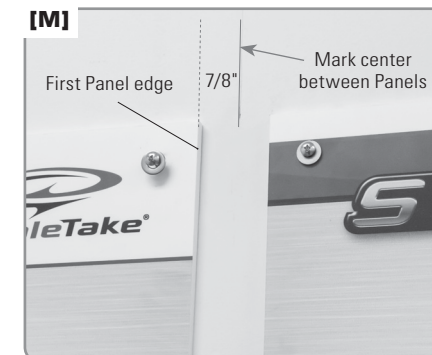

M] Mark the center of the space between the Panels. Use a level to draw a plumb line high enough to align the edge of the Header.

POSITION HEADER AND MARK MOUNTING HOLES



N] ** 2-PERSON JOB** Place the Header onto the 1" tall wood spacers (taken from Jigs in **(K)** above).
• Align the edge of Header with the center line marked in **(M)** above. Mark the mounting locations. — **NOTE:** make sure to use the exact Header to be installed to mark hole locations, as the positions can vary since they are hand-drilled.

DRILL 5/16" HOLES IN HEADER CORNERS



O] Remove Header and install Wall Anchors.
• Replace Header and temporarily install top 2 screws.
****DO NOT FULLY TIGHTEN****

ESTABLISH POSITION FOR REMAINING HEADERS

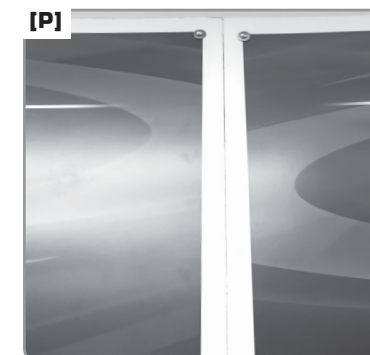

P] Continue to place Headers and mark Wall Anchor locations. Make sure to use the 1" wood spacers and butt the edges of the headers together **(P). Continue until all Headers have been positioned.**

4 FINAL INSTALLATION

MARK ALL MOUNTING LOCATIONS AND REMOVE ALL PANELS & HEADERS



Q] Attach Plank Foam (x2) to the back of each Panel & Header, approximately at each third, to help support Panel centers.



R] Reinstall all Panels & Headers using the 1" Black Spacers. **FULLY TIGHTEN HARDWARE******

Panel and Header installation is now complete. If you have **Section 08 - Cushion Samples**, proceed to instructions on the next page...